

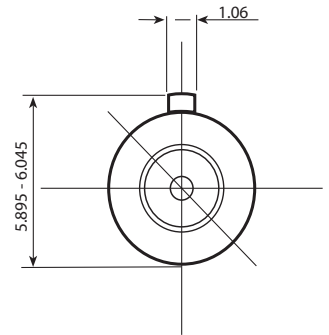

Revisions			
Rev.	Description	Date	Approved

Drawing No.: **MT2051** Rev.:

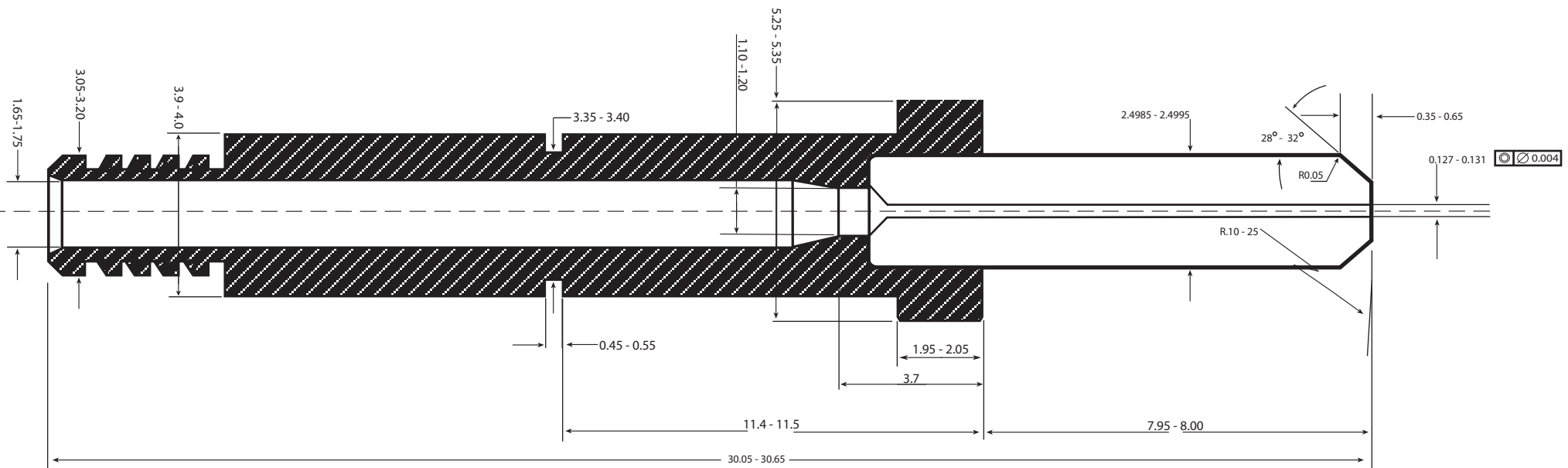

- Notes:
1. Drawing in mm unless otherwise noted
 2. Drawing not to scale
 3. Concentricity of ID 0.004
 4. Circularity of OD 0.001

 <p>213 1st ST NW - PO Box 280 Rolla, ND 58367 701-477-3193 (P) - 701-477-6579 (F) www.microlap.com</p>	<p>Drawing No.: MT2051 Rev.:</p>		
	<p>Description: ST MM Ferrule w/ Flange - 127</p>		
<p>Proprietary and Confidential</p> <p>This drawing and the information contained in the specifications are the exclusive and proprietary property of Microlap Technologies, Inc. This information and materials shall not be disclosed, divulged, reproduced, copied or used in any manner without the express written authorization of Microlap Technologies, Inc. All copies, reproductions, or other duplications of any portion of this information or materials shall include this legend.</p>	<p>Finish Requirements: Up to 0.025 Micrometers RA on ID and OD</p>	<p>Material: Ceramic</p>	
	<p>CG</p>	<p>3/2008</p>	<p>dv 4/2008</p>
<p>Drawn By:</p>	<p>Date:</p>	<p>Approved By:</p>	<p>Date:</p>